

Protected-Mode Address Translation

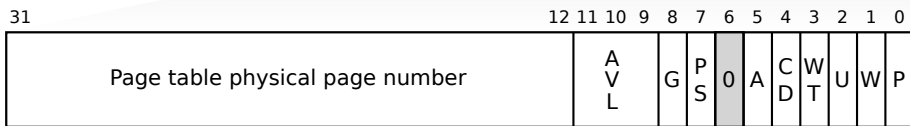

PDE

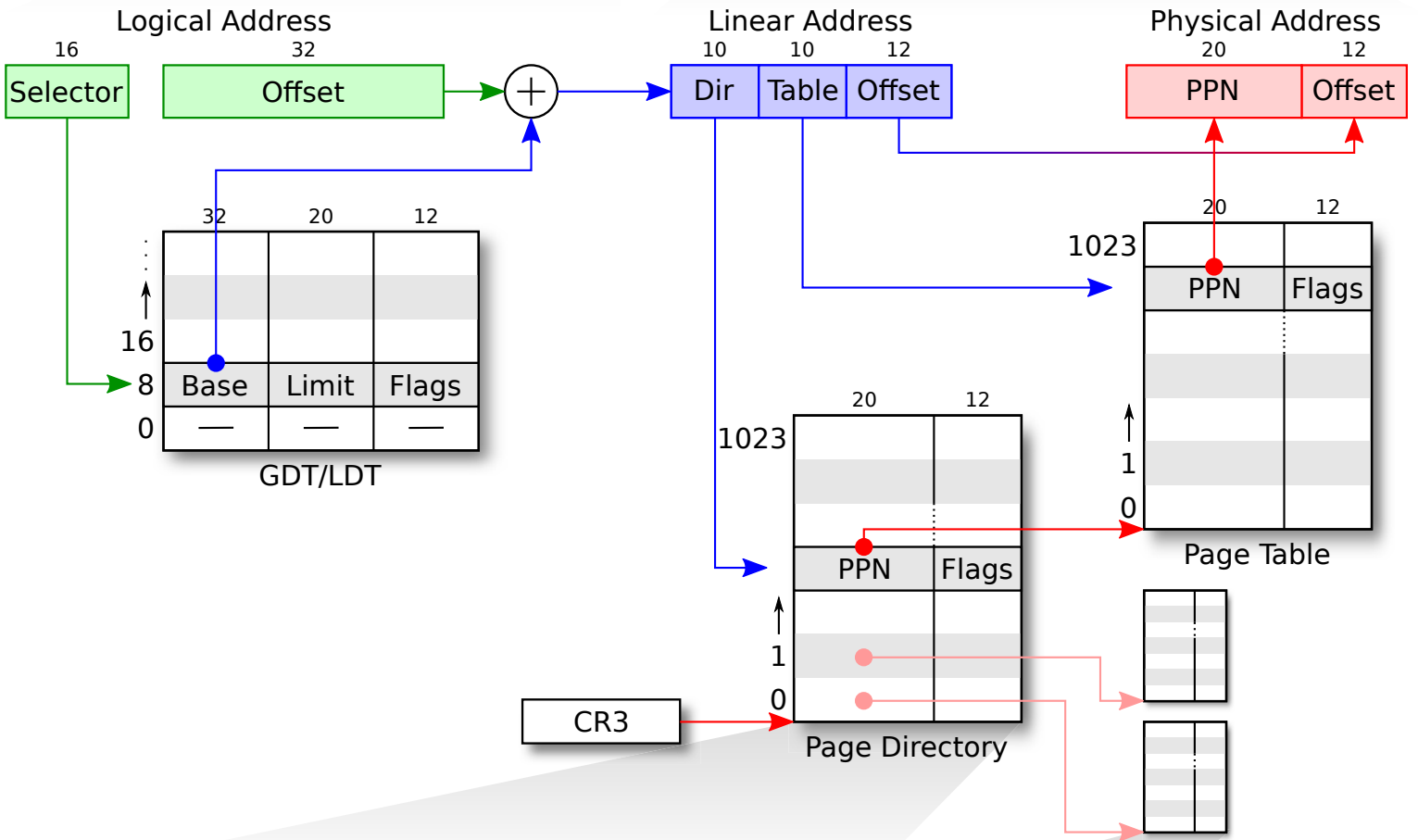
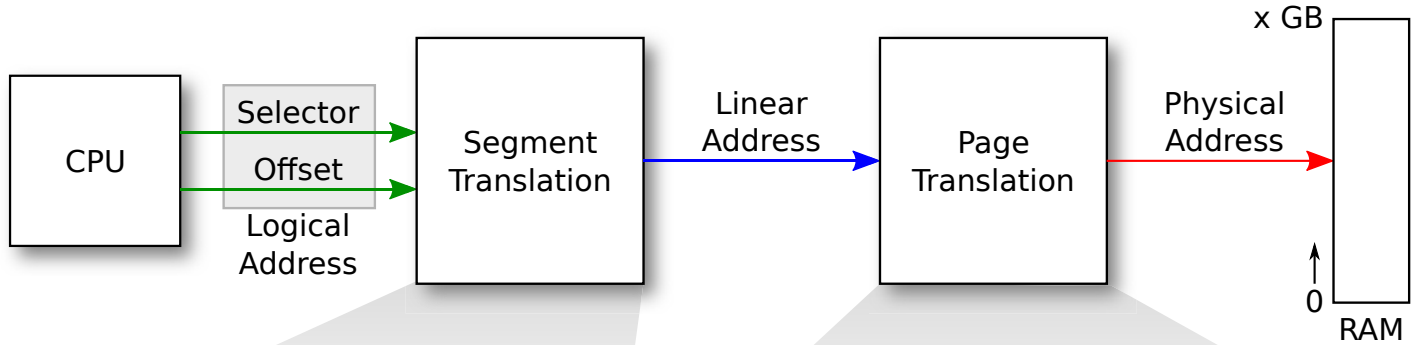
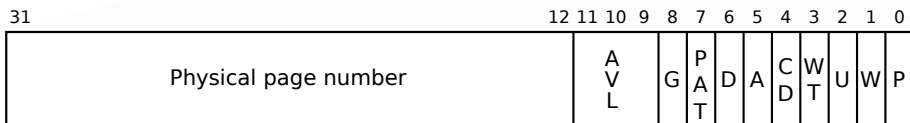

PTE

- P Present
- W Writable
- U User
- WT 1=Write-through, 0=Write-back
- CD Cache disabled
- A Accessed
- D Dirty
- PS Page size (0=4KB, 1=4MB)
- PAT Page table attribute index
- G Global page
- AVL Available for system use

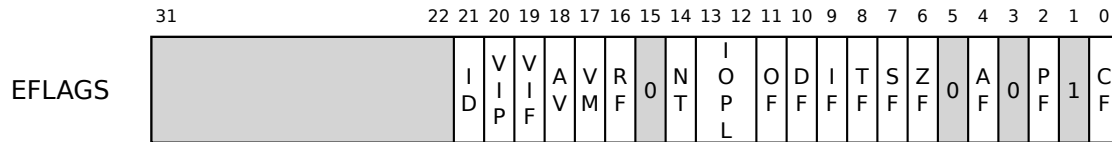

- | | | | |
|-------------------------|--------------------------|-----|-----------------------|
| Status flags | Control flags | RF | Resume flag |
| CF Carry flag | DF Direction flag | VM | Virtual-8086 mode |
| PF Parity flag | System flags | AC | Alignment check |
| AF Auxiliary carry flag | TF Trap flag | VIF | Virtual intr. flag |
| ZF Zero flag | IF Interrupt enable flag | VIP | Virtual intr. pending |
| SF Sign flag | IOPL I/O privilege level | ID | ID flag |
| OF Overflow flag | NT Nested task | | |

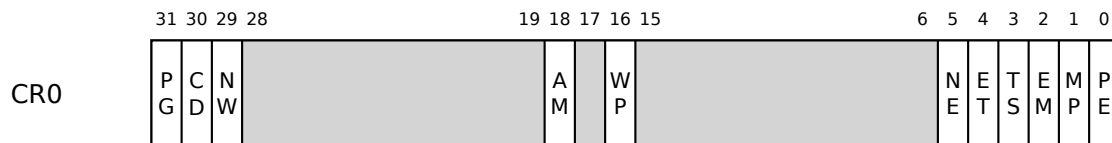

- | | | | | | |
|----|---------------------|----|----------------|----|-------------------|
| PE | Protection enabled | ET | Extension type | NW | Not write-through |
| MP | Monitor coprocessor | NE | Numeric error | CD | Cache disable |
| EM | Emulation | WP | Write protect | PG | Paging |
| TS | Task switched | AM | Alignment mask | | |

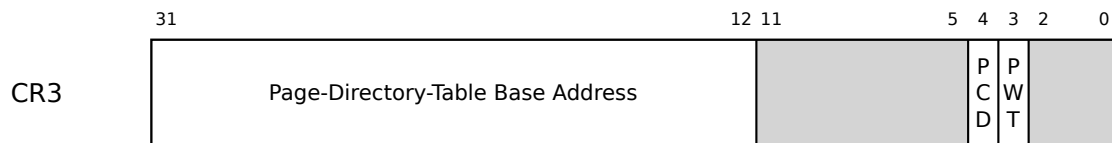

- | | | | |
|-----|-------------------------------|-----|--------------------------|
| PWT | Page-level writes transparent | PCT | Page-level cache disable |
|-----|-------------------------------|-----|--------------------------|



- | | | | |
|-----|-----------------------------------|--------|-------------------------------|
| VME | Virtual-8086 mode extensions | MCE | Machine check enable |
| PVI | Protected-mode virtual interrupts | PGE | Page-global enable |
| TSD | Time stamp disable | PCE | Performance counter enable |
| DE | Debugging extensions | OSFXSR | OS FXSAVE/FXRSTOR support |
| PSE | Page size extensions | OSXMM- | OS unmasked exception support |
| PAE | Physical-address extension | EXCPT | |

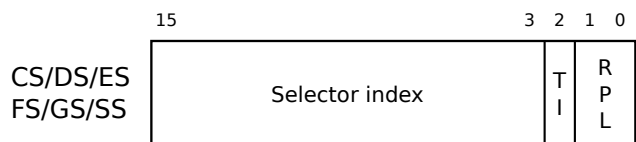

- | | |
|-----|----------------------------|
| TI | Table index (0=GDT, 1=LDT) |
| RPL | Requester privilege level |

MIT OpenCourseWare
<http://ocw.mit.edu>

6.828 Operating System Engineering
Fall 2012

For information about citing these materials or our Terms of Use, visit: <http://ocw.mit.edu/terms>.