

HST.410J/6.07J

Lecture 1
February 6, 2007

Projects in Microscale Engineering for the Life Sciences
HST.410J / 6.07J

Staff: Denny Freeman
Martha Gray
AJ Aranyosi
Janice Balzer (secretary)

Web site:
<http://umech.mit.edu/6.07J/index.html>

Microscale Engineering
Electronics

Medicine and Biology

Images removed due to copyright restrictions.

revised March 5, 2007

HST.410J/6.07J Calendar

Introductory Exercises
(weeks 1-7)

Projects
(weeks 8-14)

Tuesday		Thursday		Tuesday		Thursday	
	2/6 L1		2/8 L2	Project Proposal Due	4/3 L14	Homework #6 Due	4/5 L15
Microfluidics		Microfabrication		Projects		Projects	
	2/13 L3		2/15 L4		4/10 L16		4/12 L17
Cells and Membranes		Cells and Membranes		Projects		Projects	
Homework #1 Due	2/20		2/22 L5		4/17		4/19 L18
No Lecture / No Lab		Models of Diffusion & Cell Experiment		Patriot's Day No Lecture / Lab		Projects	
Homework #2 Due	2/27 L6		3/1 L7		4/24 L19		4/26 L20
Laminar Flow		Data Analysis using Matlab		Projects		Projects	4/26 L20
Homework #3 Due	3/6 L8		3/8 L9		5/1 L21		5/3 L22
Research Applications		Research Paper Discussion		Projects		Projects	5/3 L22
Homework #4 Due	3/13 L10		3/15 L11		5/8 L23		5/10 L24
Research Applications		Cell Traps		Project Presentation Dry Runs		Project Presentation Dry Runs	5/10 L24
Homework #5 Due	3/20 L12		3/22 L13		5/15 L25		5/17 L26
Cell Traps		Statistics		Project Presentations		Project Presentations	5/17 L26

Spring Week

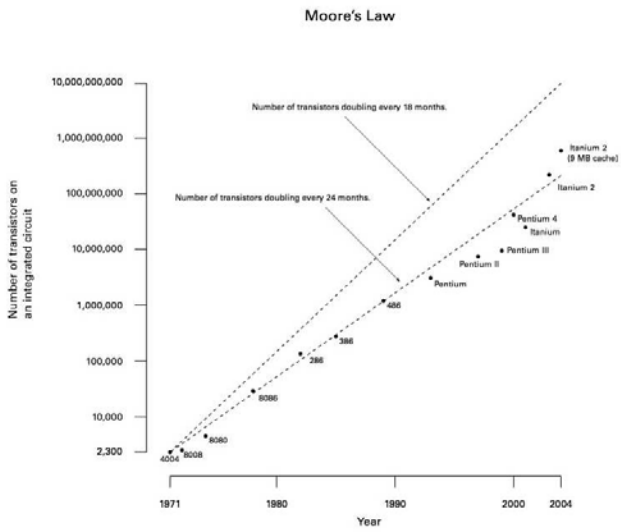

<http://en.wikipedia.org>

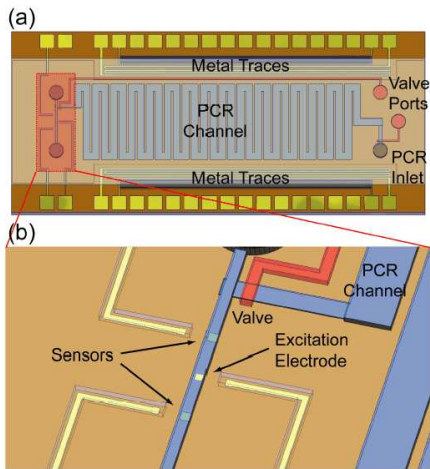

Johnson Hou and Prof. Scott Manalis

Johnson Hou MIT PhD thesis, 2007

Image removed due to copyright restrictions.

Micro/Nano Fluidics

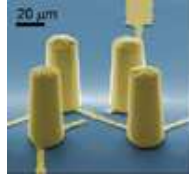
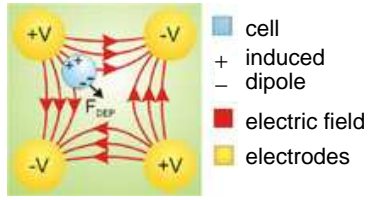
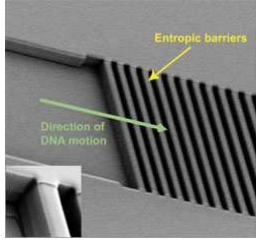
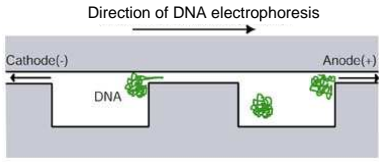

Courtesy of JongYoon Han. Used with permission.

Courtesy of Joel Voldman. Used with permission.

JongYoon Han

Joel Voldman

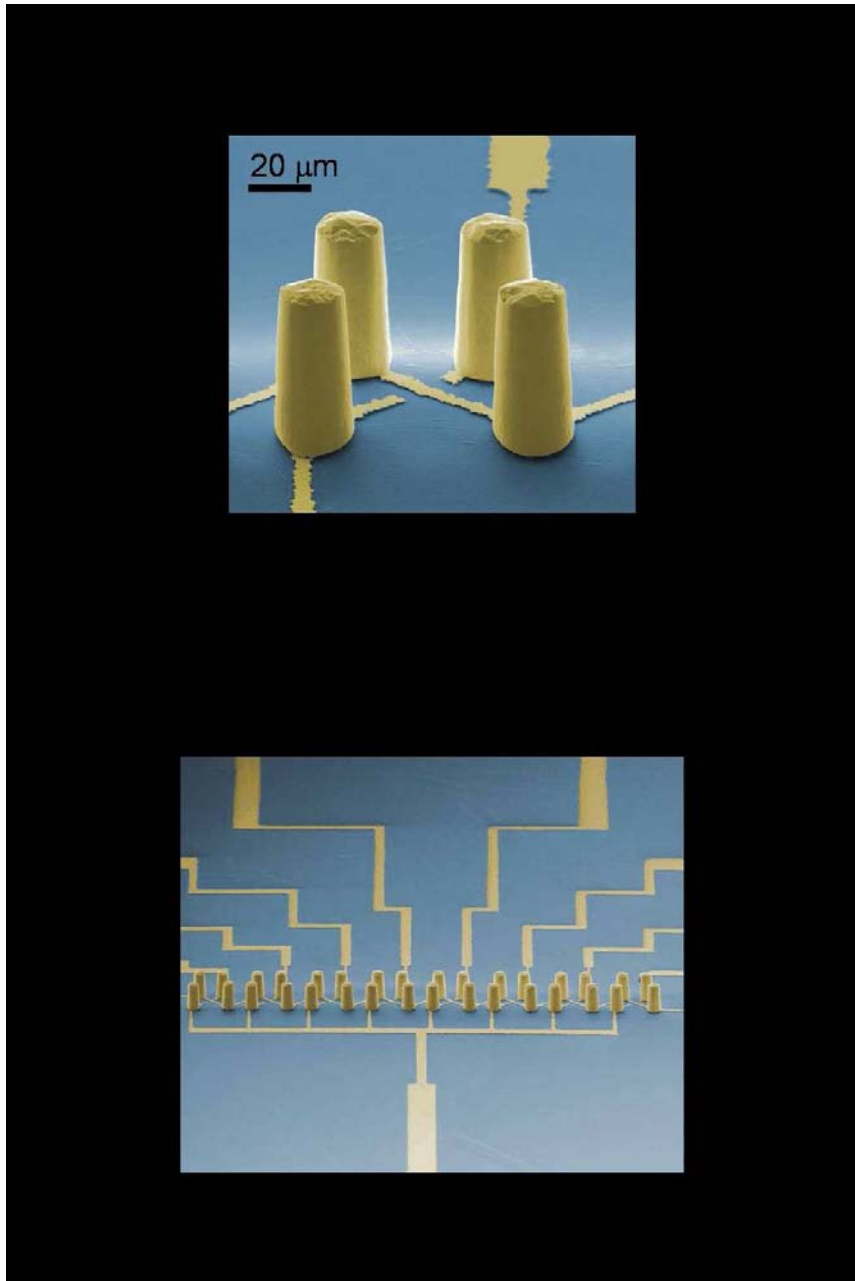

Courtesy of Joel Voldman. Used with permission.

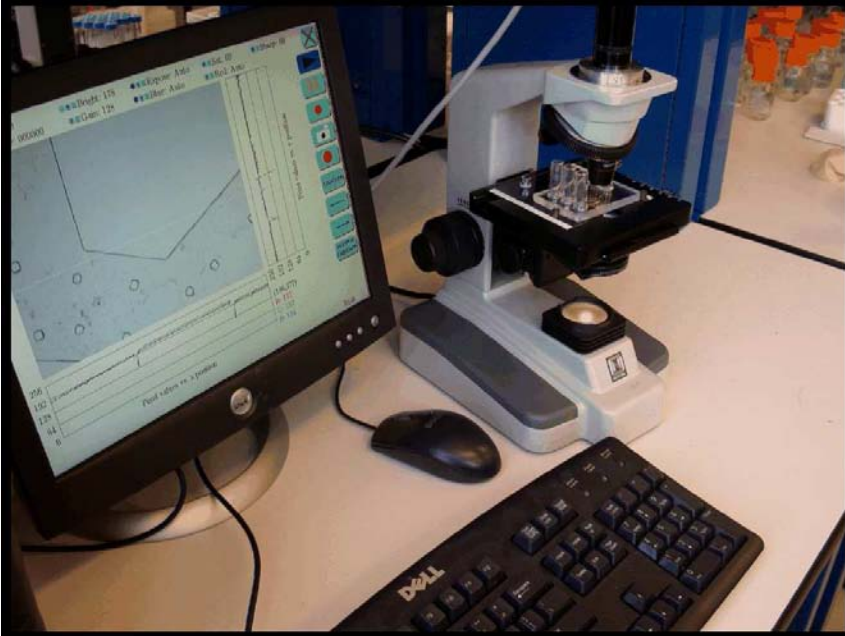
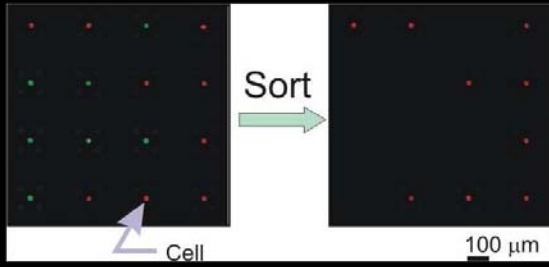

Data Set 000
 Bright: Auto
 Expose: Auto
 Sat: 60
 Sharp: 60
 Next Image: 000084
 Gain: 128
 Blue: Auto
 Red: Auto

Avg

Pixel values vs. y position

256
192
128
64
0

Pixel values vs. x position

256
192
128
64
0

screen capture

RGB

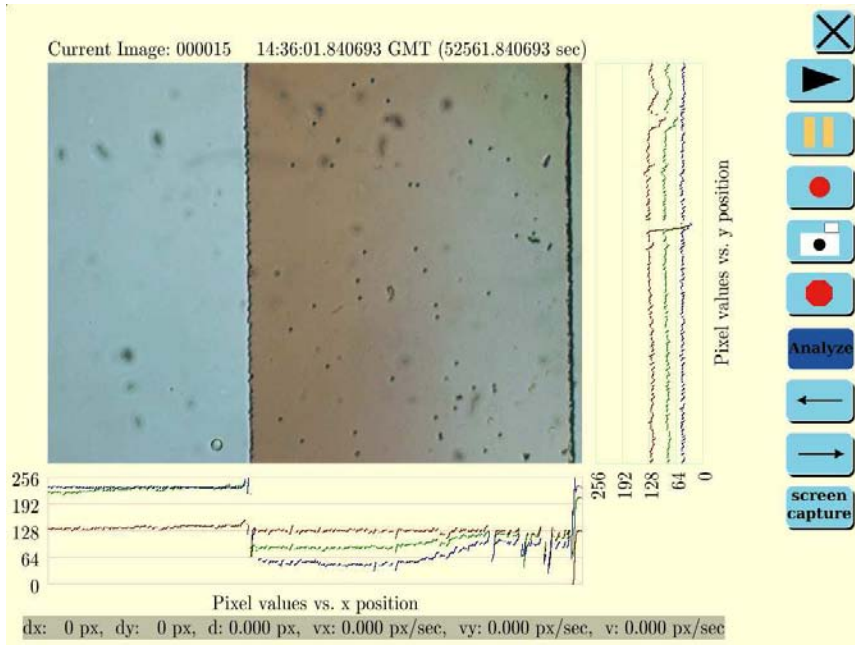

info.123456.txt

```

14:32:56.935655 GMT (52376.935655 sec)
RGB Values for Row 215
k_value R G B
000 141 173 178
001 142 174 179
002 142 174 179
003 141 173 178
004 141 173 179
005 142 174 180
006 141 173 179
007 141 173 179
008 139 175 180
009 139 175 180
010 139 175 180
011 139 175 180
...
637 137 161 143
638 138 162 144
639 138 162 144

RGB Values for Column 447
y_value R G B
000 133 125 095
001 136 126 094
002 135 131 096
003 136 131 092
004 136 129 103
005 136 130 101
006 137 130 104
007 144 133 106
008 149 137 108
009 149 143 112
010 149 143 112
011 148 136 107
...
477 134 132 128
478 133 133 124
479 141 136 125

```

image.123456.bmp

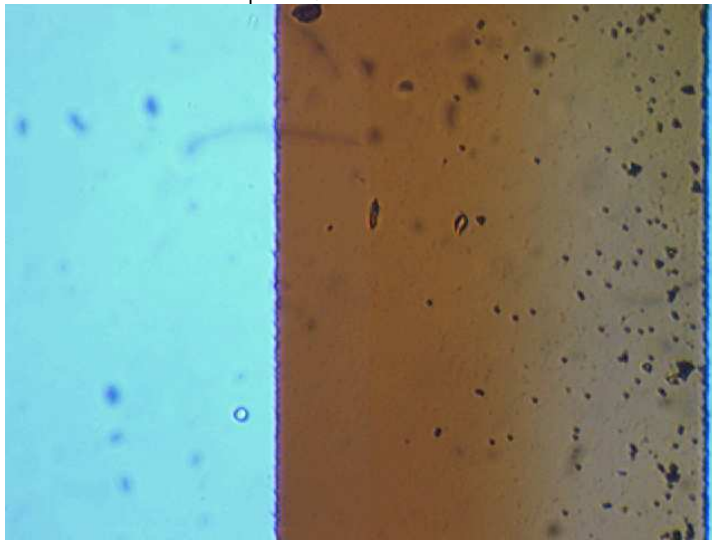

O-Ring Fluid Reservoirs



Chrome Mask

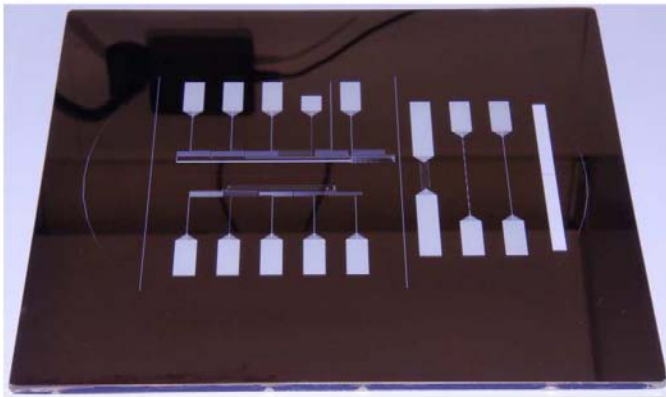

Silicon Master

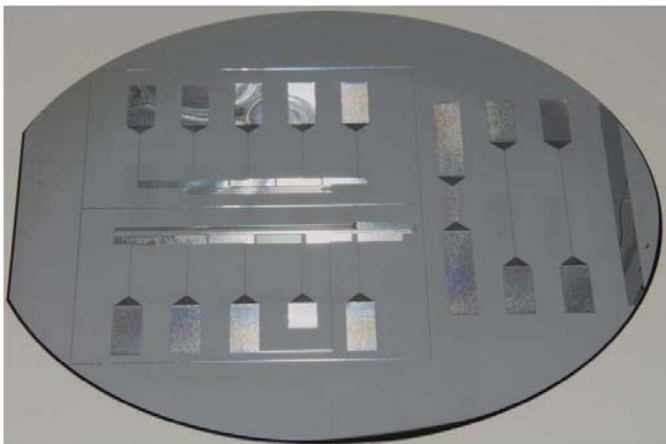

PDMS Cast of Master

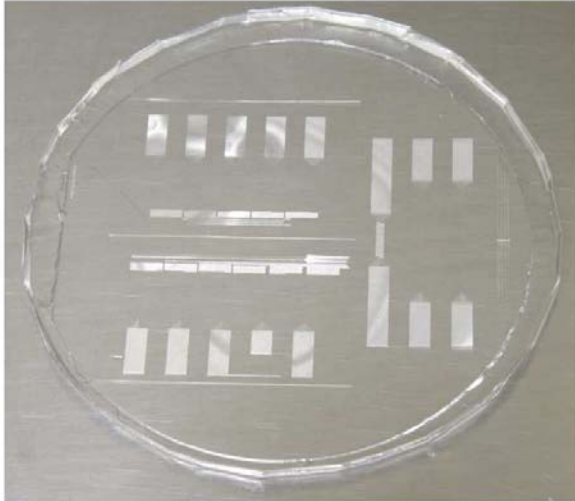

Unpunched PDMS Device

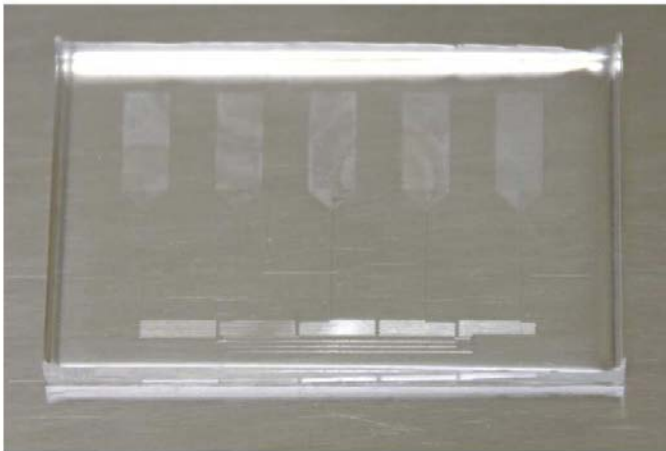

Plastic Master and Source Mold



Plastic Master Of PDMS Device



Washing Mold With Soap And Water



Rising Mold In Deionized Water



Rinsing Mold With Isopropyl Alcohol

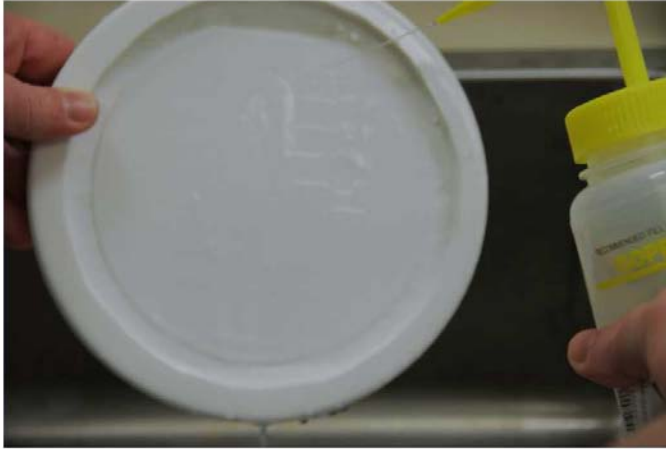

Drying Mold With Compressed Air



Removing Excess Crud With Tape



Pouring PDMS



Popping Bubbles In PDMS

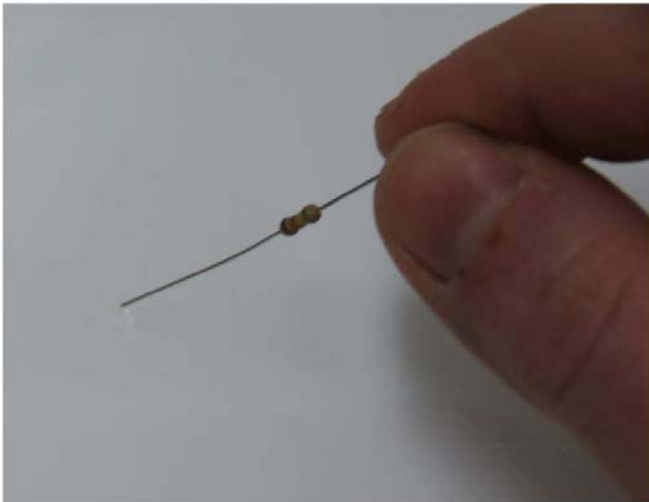

Placing Mold And PDMS In Oven



Proper Oven Settings For Baking PDMS



Unpunched PDMS Device

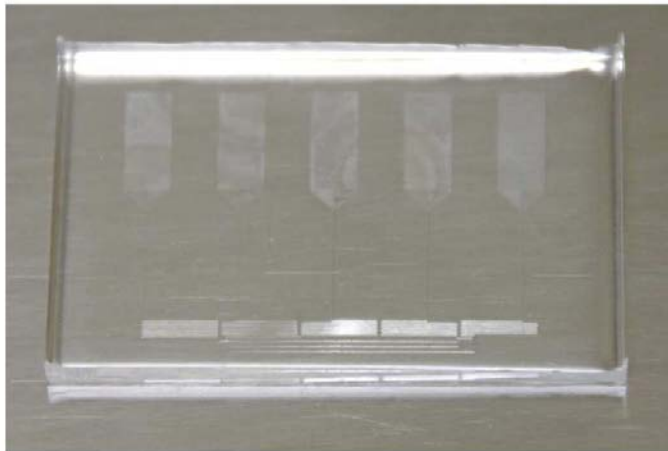

PDMS and Glass on Taped Slides



Placing Device In Plasma Cleaner



Plasma Cleaner On



Vacuum Ready



Plasma Cleaner On



Plasma Without Oxygen



Plasma With Oxygen



Device Partially Bonded To Glass



PDMS Device With Holes Punched

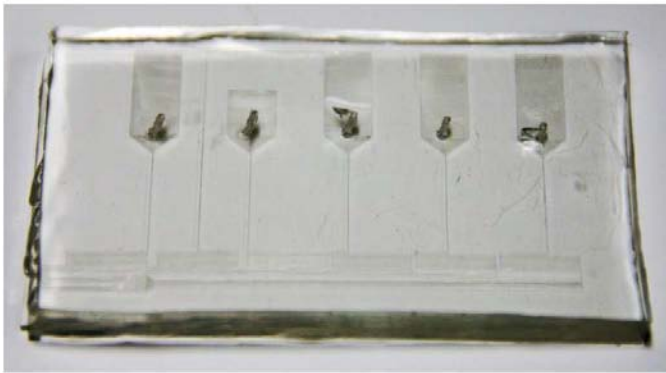

PDMS Device With Pipette Reservoir



PDMS Device With Punched Syringe Holes

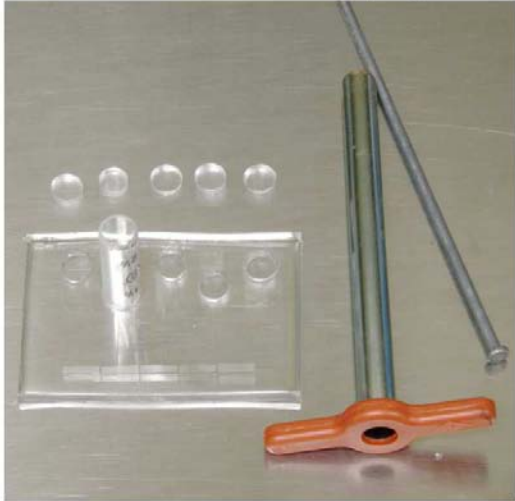

Plastic Master Of PDMS Device

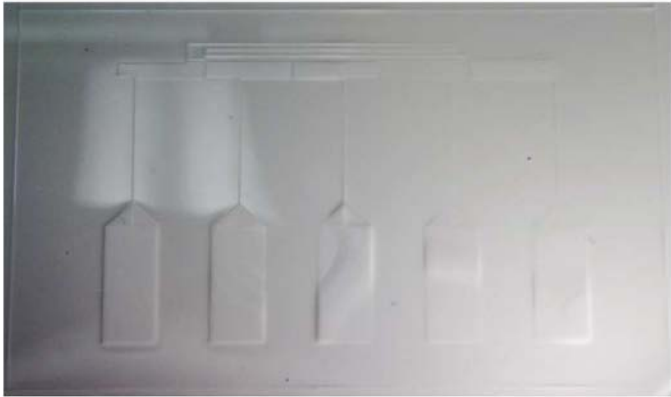

Plastic Master With O-Ring Molds



O-Ring Fluid Reservoirs



PDMS Reservoirs



PDMS Reservoir Bonded To Device

