

Motion Blur and Chicken Heads

Anonymous MIT student

Computational Photography 2009

A moving camera creates blur

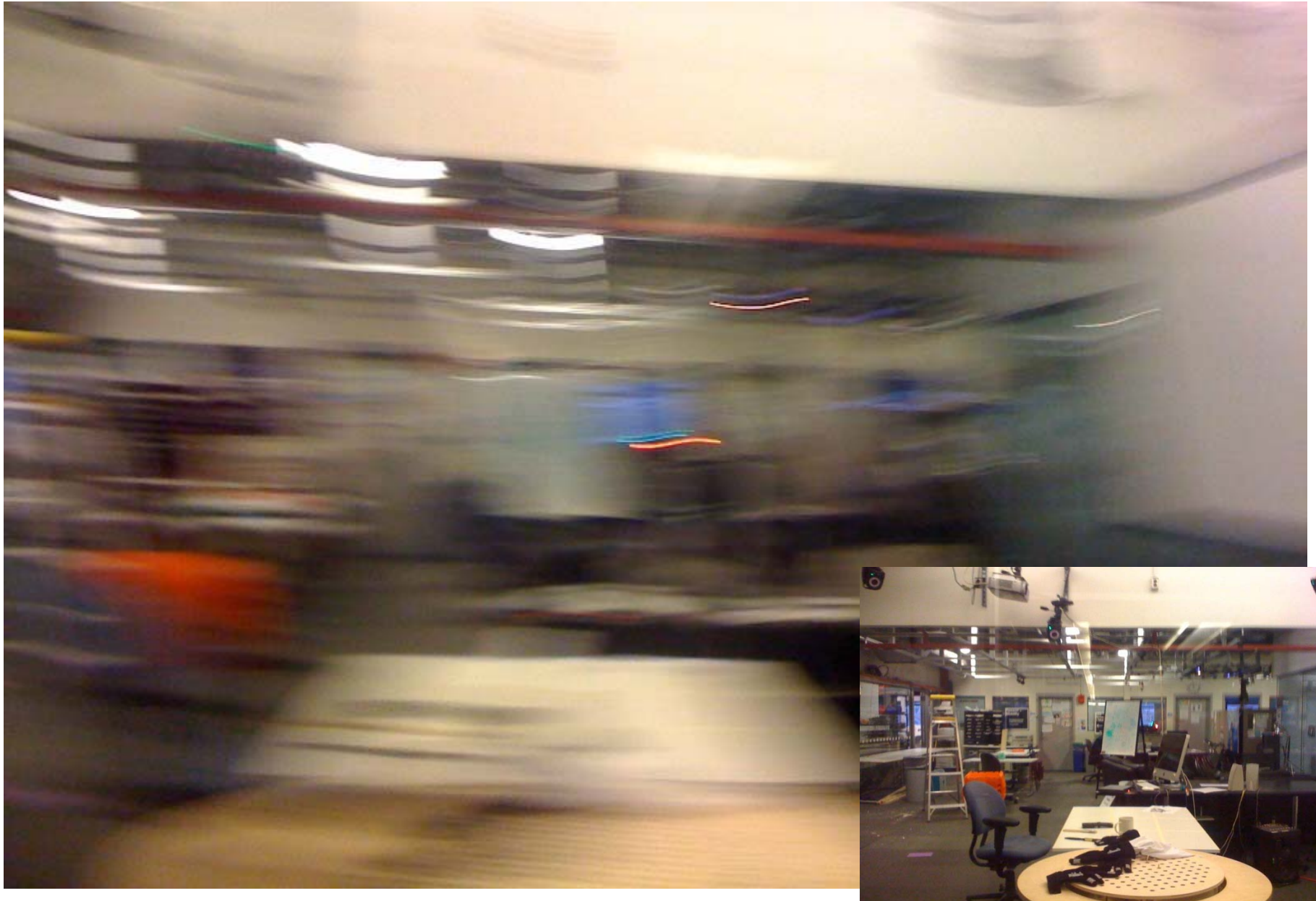

Current solutions

Moving Film

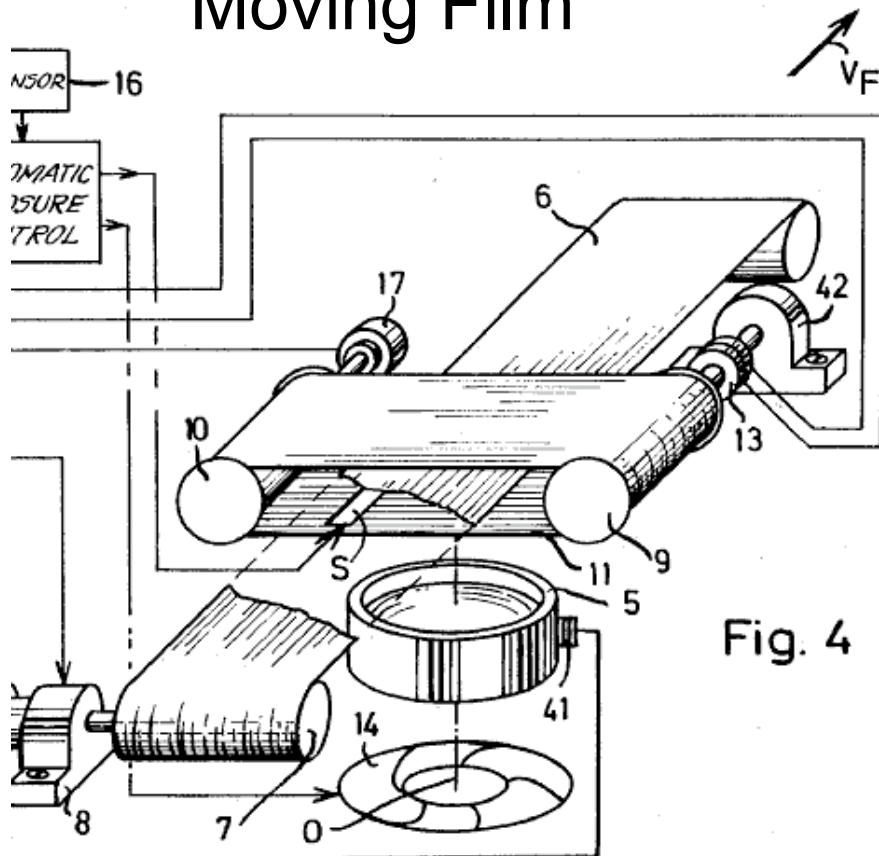

Prinz, Reinhard. 1985. Method and means for compensating for image motion in an aerial camera. United States Patent 4,505,559

Multiple cameras in a line

Drawing of camera system removed due to copyright restrictions. See Fig. 6 in Leberl, F. et al. (2003). "The ultracam large format aerial digital camera system." *Proceedings of the American Society For Photogrammetry & Remote Sensing*, pp. 5-9. <http://vicos.fri.uni-lj.si/data/publications/leberl03the.pdf>

Schematic of airplane-based Leica Geosystems ADS40 imaging system removed due to copyright restrictions. See Fig 5 in Leberl, F. et al. (2002). "Novel Concepts for Aerial Digital Cameras." *Proceedings of the ISPRS Commission I Symposium*. <http://vicos.fri.uni-lj.si/data/publications/leberl02novel.pdf>

Linescan cameras

Nature Inspired



Still image from video by destinws2. "Chicken Head Tracking – Pennywhistle Productions." 15 June 2008. YouTube. Accessed 1 June 2010. <http://www.youtube.com/watch?v=dPIkFPowCc>

Courtesy of Destin Sandlin. Used with permission.

Idea: Don't Move the Camera (relatively)

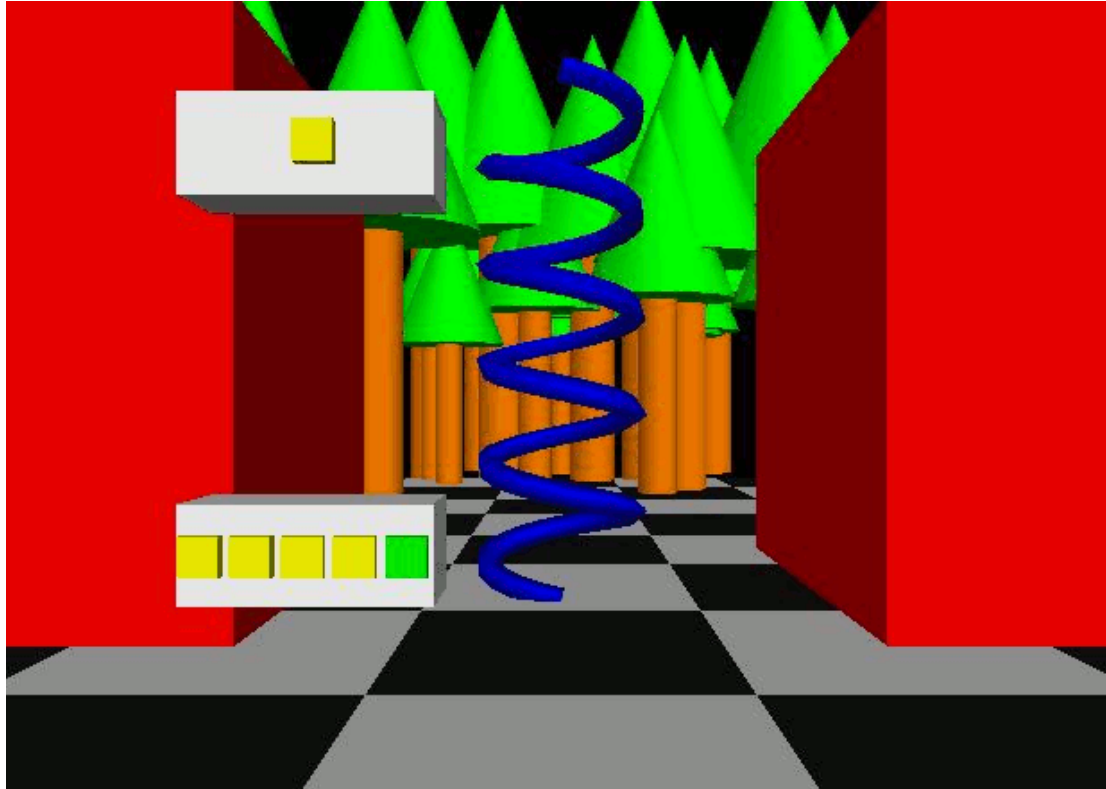

Benefits

- Digital
- More light
- Consistent angle

Limitations

- Moving parts
- Speed sensor
- 1 dimensional

Simulated Results

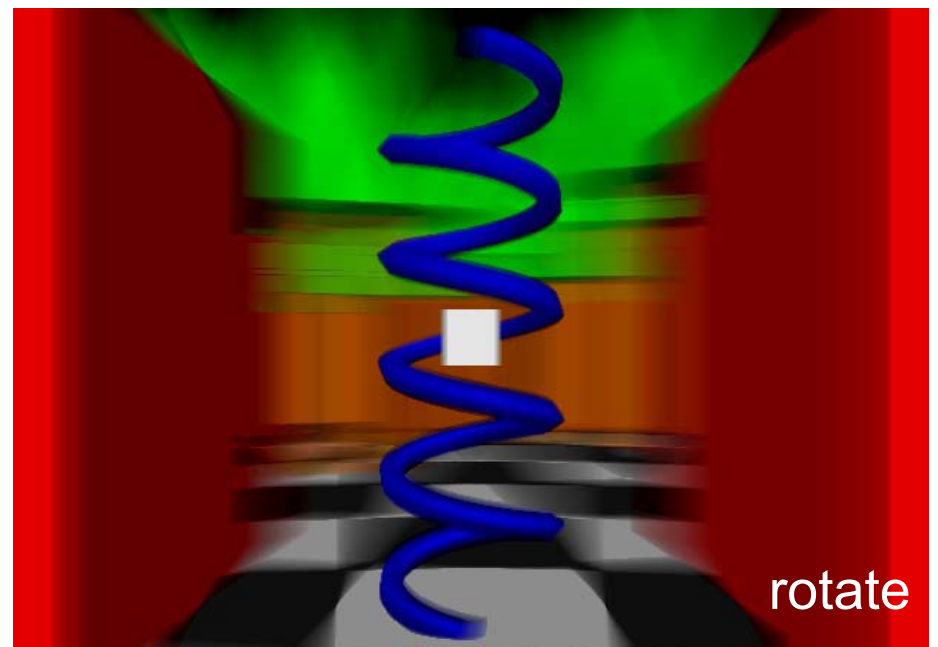
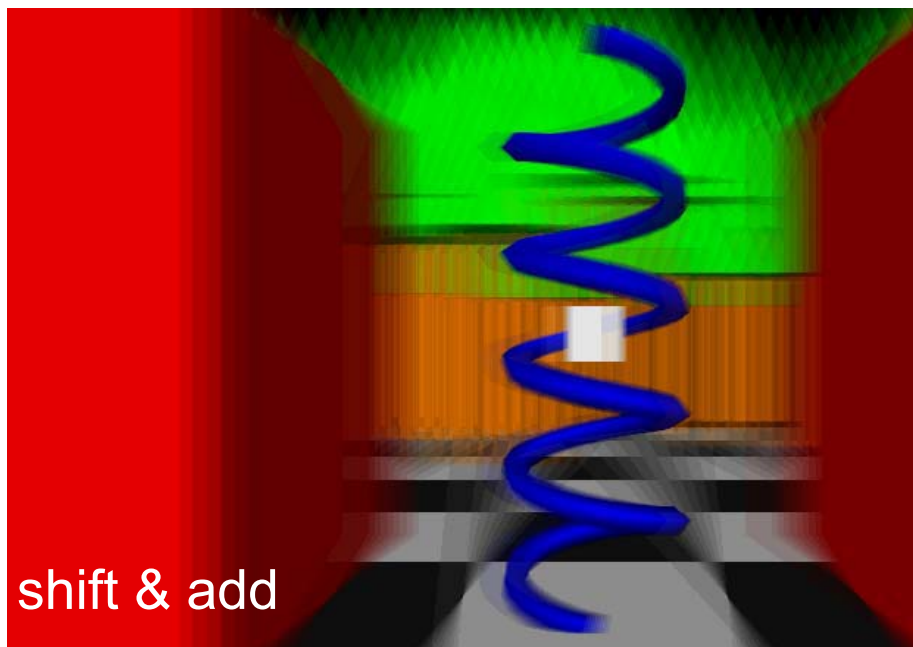
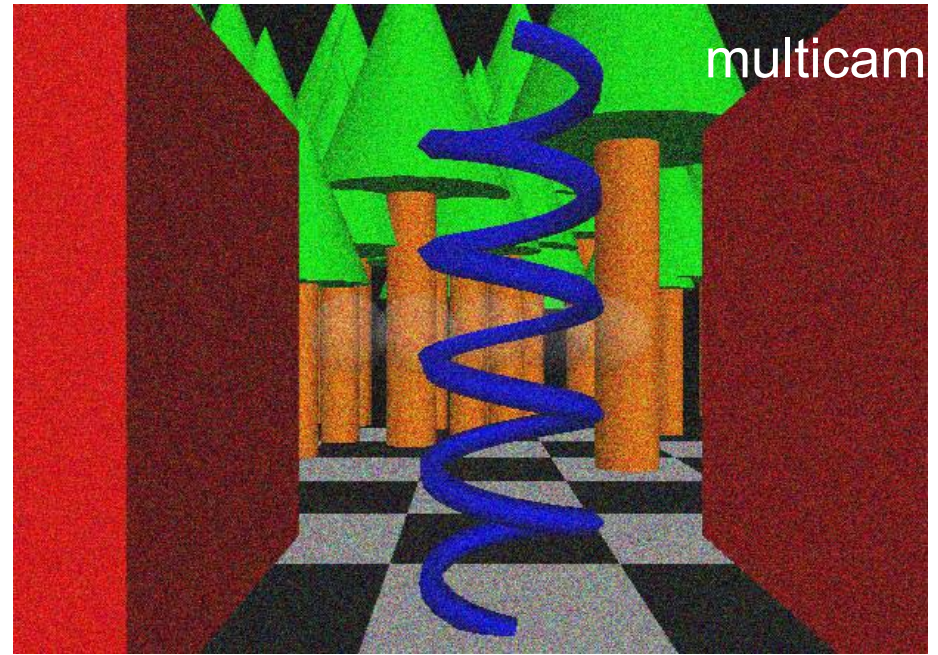
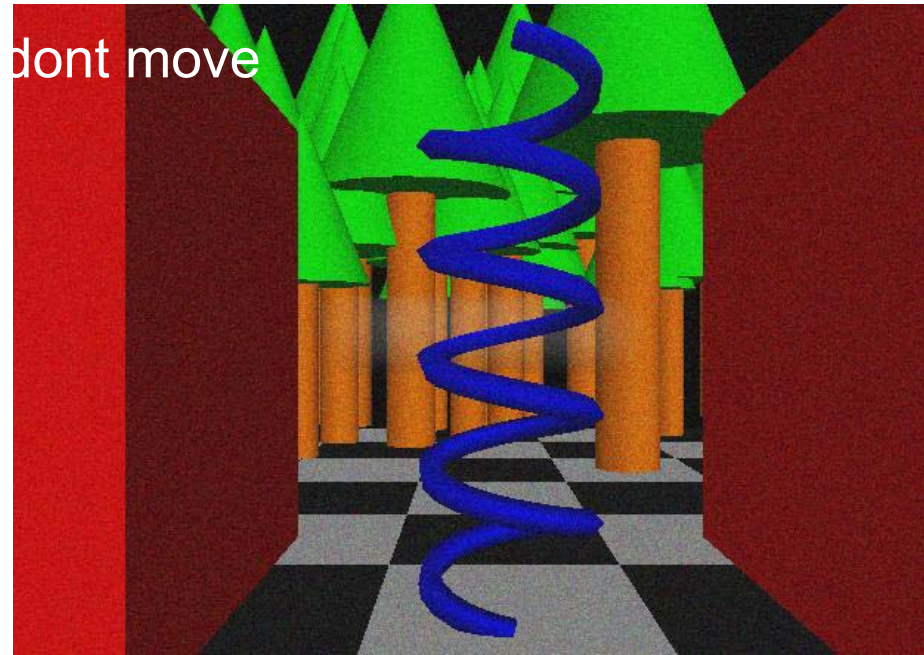

Physical Prototype



Performance

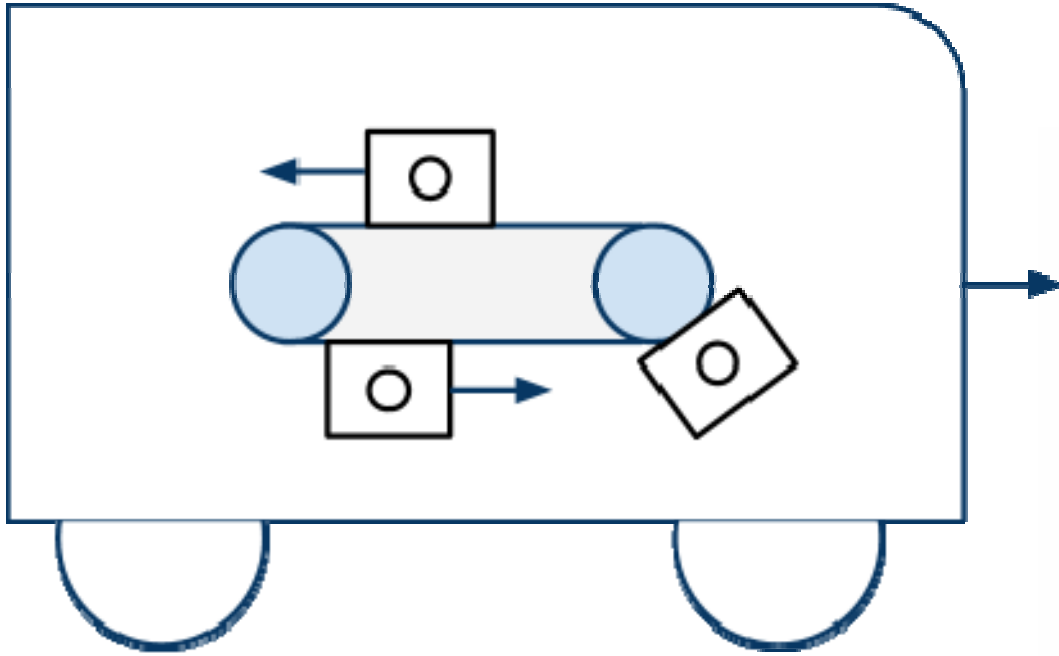

Prototype

- Chain vibrates camera
- Camera wires tangle
- Two cameras not enough
- Unreliable direct-drive
- < \$20

Future

- Smooth belt systems
- wireless
- many, small cameras
- Sensors and motors
- \$\$\$\$

Summary

Q. How do we take a sharp image of a static scene from a moving vehicle?

A. Don't move the camera

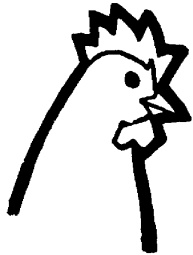

6D robot arms

Photo of robot arm removed due to copyright restrictions.

South Facing Chariot

Photo of chariot removed due to copyright restrictions.

Google Street View

Photo of car with cameras attached to roof removed due to copyright restrictions.

MIT OpenCourseWare
<http://ocw.mit.edu>

MAS.531 Computational Camera and Photography
Fall 2009

For information about citing these materials or our Terms of Use, visit: <http://ocw.mit.edu/terms>.